



ACCESSORIES

WARNING

Accessories which are not properly fitted can be dangerous. Read the instructions carefully prior to fitting. Whilst fitting, comply with the instructions at all times. If in doubt, contact your nearest Land Rover Dealer.

ACHTUNG!

Nicht sachgemäß montiertes Zubehör kann gefährlich sein. Lesen Sie die Montageanleitung sorgfältig, bevor Sie das Teil montieren. Halten Sie sich bei der Montage an die Anleitung. Bei Unsicherheiten wenden Sie sich bitte an Ihren Land Rover Händler.

AVERTISSEMENT

Les accessoires qui ne sont pas correctement montés risquent d'être dangereux. Veuillez lire soigneusement les instructions avant d'effectuer la pose. Respectez toujours les instructions en cours de pose. En cas de doute, consultez votre concessionnaire Land Rover local.

AVVERTENZA

Gli accessori non sistemati come previsto possono essere pericolosi. Leggere attentamente le istruzioni prima del fissaggio. Durante il montaggio seguire sempre le relative istruzioni. In caso di dubbio rivolgersi al più vicino concessionario della Land Rover.

AVISO

Aquellos accesorios que no hayan sido ajustados debidamente pueden resultar peligrosos. Lea las instrucciones detenidamente antes de iniciar el montaje. Durante el montaje siga las instrucciones en todo momento. En caso de duda póngase en contacto con su Concesionario de Land Rover.

ADVERTÊNCIA!

Os Acessórios que não são montados adequadamente podem ser perigosos. Leia as instruções cuidadosamente antes de montar. Durante a montagem, obedeça as instruções todo o tempo. Se tiver alguma dúvida, contacte o Concessionário LandRover mais próximo.

WAARSHCUWING

Accessoires die niet op de juiste wijze zijn gemonteerd kunnen gevaar opleveren. Lees zorgvuldig de instructies alvorens met de montage te beginnen. Houd u tijdens de montage te allen tijde aan de instructies. Neem bij twijfel contact op met de dichtstbijzijnde Land Rover dealer.

ΠΡΟΕΙΔΟΠΟΙΗΣΗ

Τα προαιρετικά εξαρτήματα που δεν έχουν τοποθετηθεί σωστά μπορεί να είναι επικίνδυνα. Διαβάστε τις οδηγίες πριν προχωρήσετε στην τοποθέτησή τους. Κατά την τοποθέτηση, τηρείτε συνεχώς τις οδηγίες. Αν έχετε οποιαδήποτε αμφιβολία, επικοινωνήστε με τον πλησιέστερο αντιπρόσωπο της.

注意

正しく取り付けられていない備品があると、事故の原因になります。取付ける前にこのマニュアルをよくお読みください。取付けの際は必ずこのマニュアルにある指示に従ってください。何か不明な点がありましたら、お近くのランド・ローバー社のディーラーまでお問い合わせください。



FITTING INSTRUCTION

Fog Lamp Kit

EINBAUANLEITUNG

Baus. Nebellampen

INSTRUCTION DE MONTAGE

Kit feu a'brouillard

ISTRUZIONI PER L'USO

Kit fari antinebbia

INSTRUCCIONES DE MONTAJE

Jeugo faros antiniebla

INSTRUÇÕES DE MONTAGEM

Kit de farol de nevoeiro

MONTAGEHANDLEIDING

Mistlampenset

ΟΔΗΓΙΑ ΤΟΠΟΘΕΤΗΣΗΣ

Κιτ Προβολέων Ομίχλης

取付用マニュアル
フォグ ランプ キット

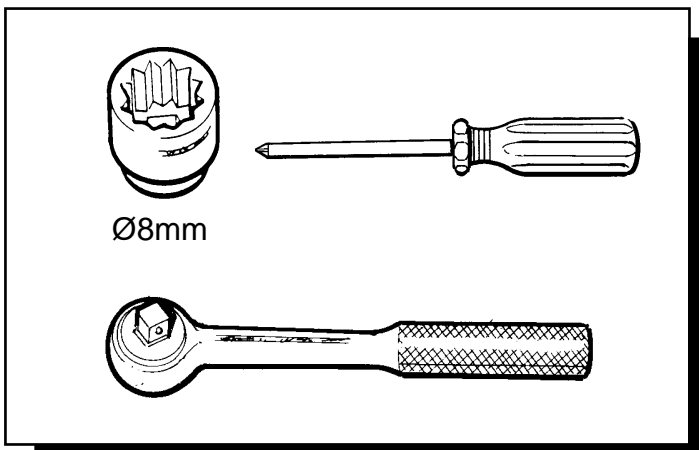
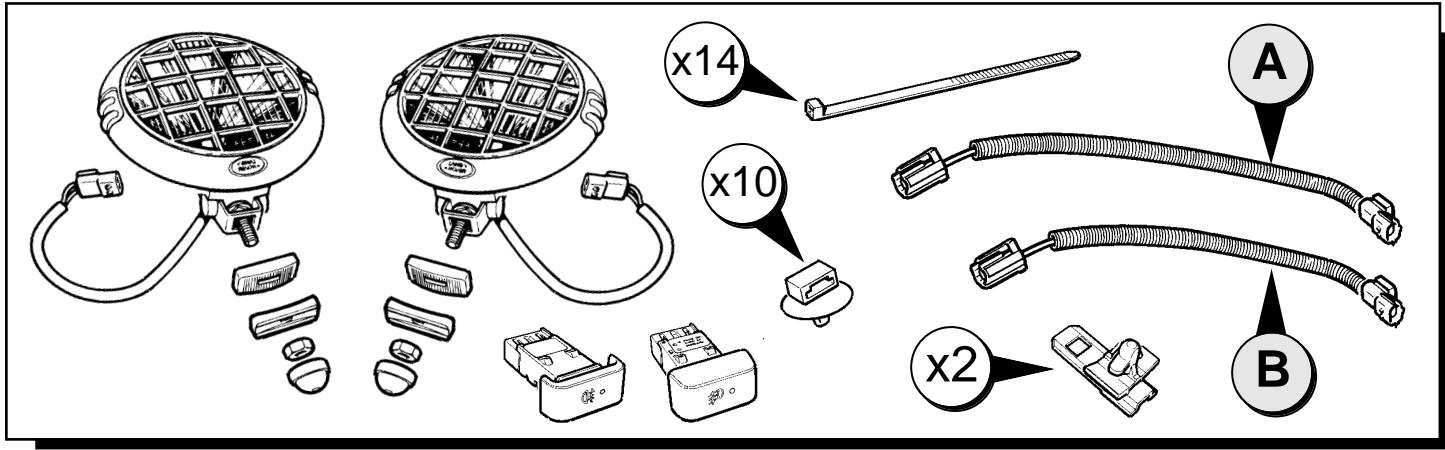
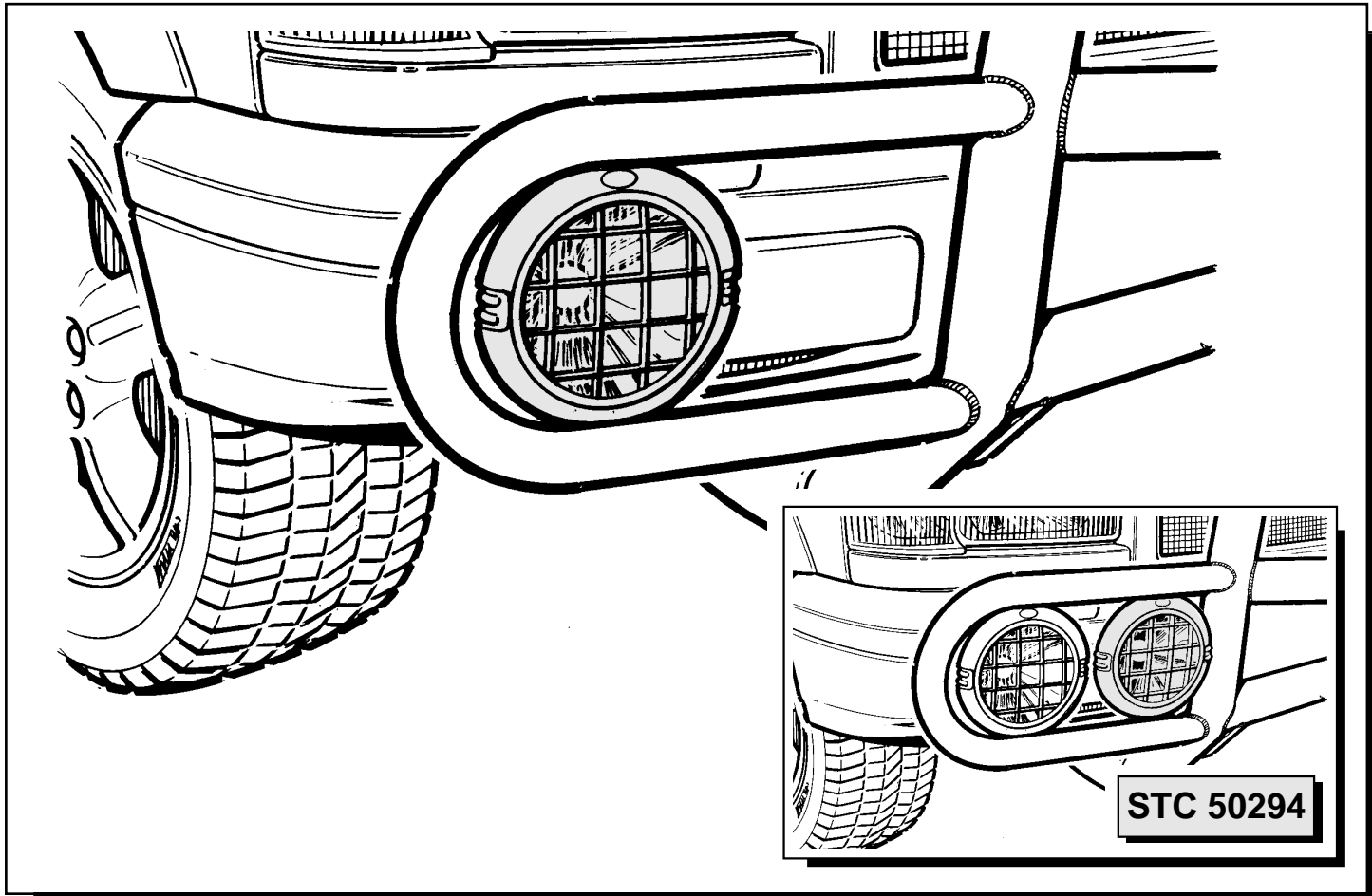

- (GB) The following instructions are valid for both sides of the vehicle.
- (D) Folgende Anweisungen gelten für beide Fahrzeugseiten.
- (F) Les instructions suivantes sont applicables aux deux côtés du véhicule.
- (I) Les istruzioni seguenti sono valide per entrambe le fiancate della Vettura.
- (E) Las siguientes instrucciones son válidas para ambos lados del vehículo.
- (P) As instruções a seguir aplicam-se a ambos os lados do veículo.
- (NL) De volgende instructies zijn van toepassing op beide zijden van de auto.
- (GR) Οι ακόλουθες οδηγίες ισχύουν και για τις δύο πλευρές του οχήματος.
- (B) 次の取付け方法は車の両サイドに適用できます。

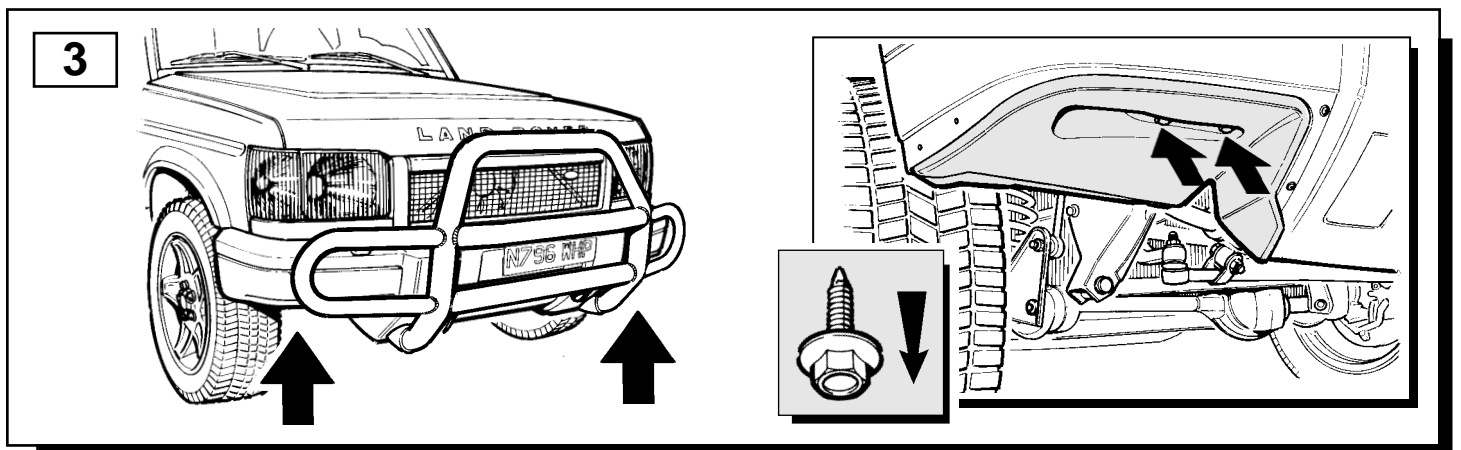
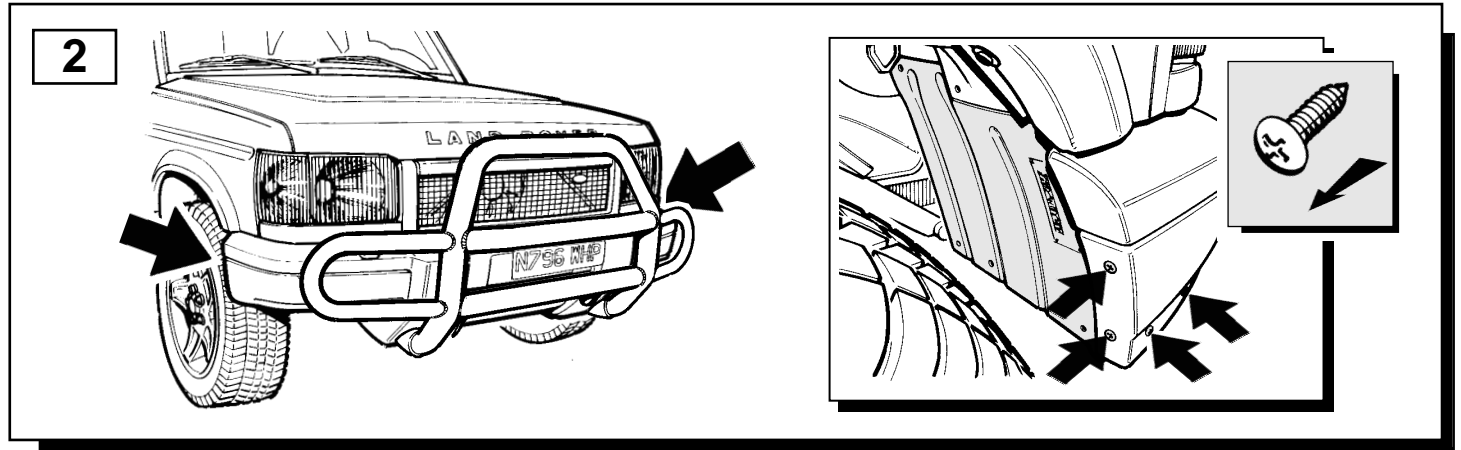
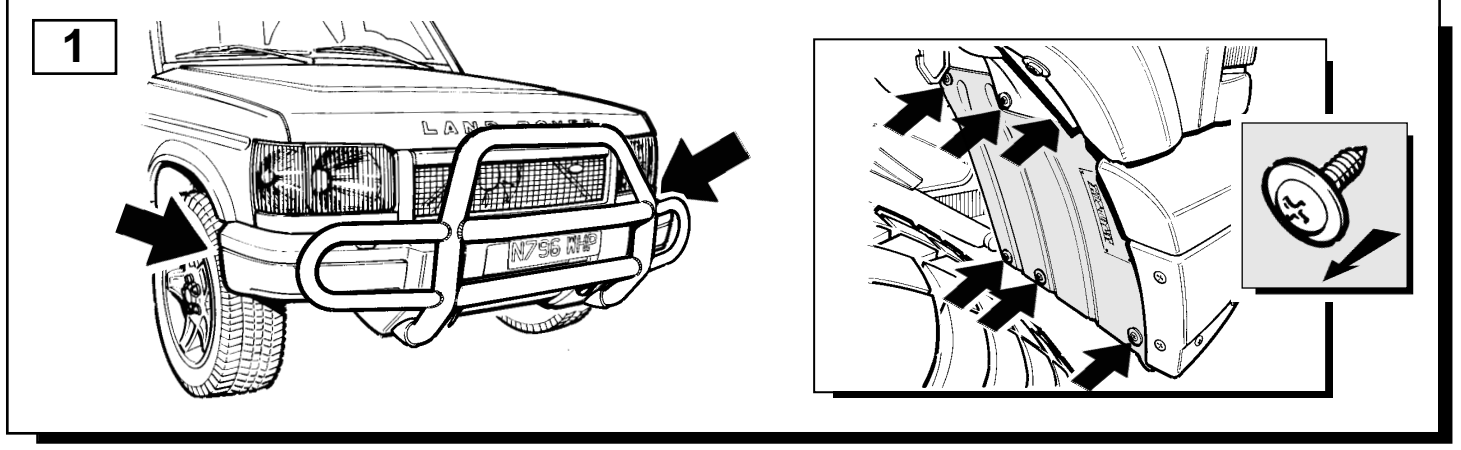

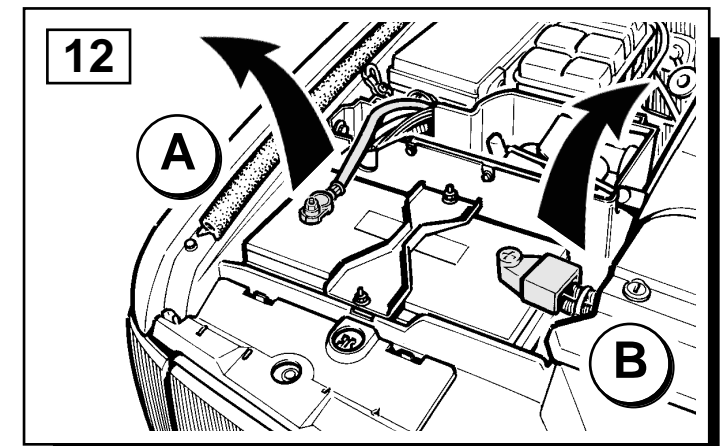
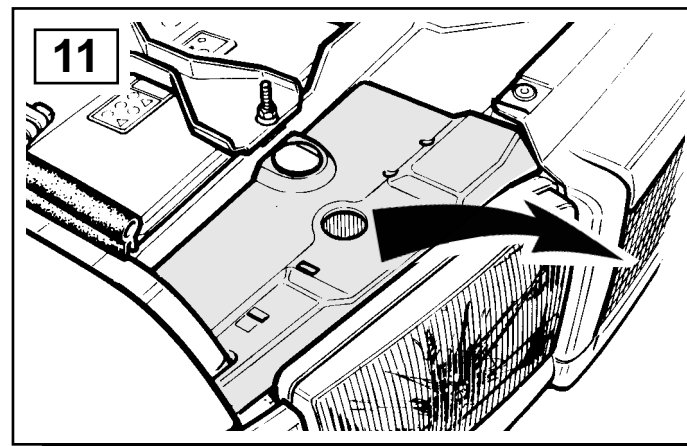
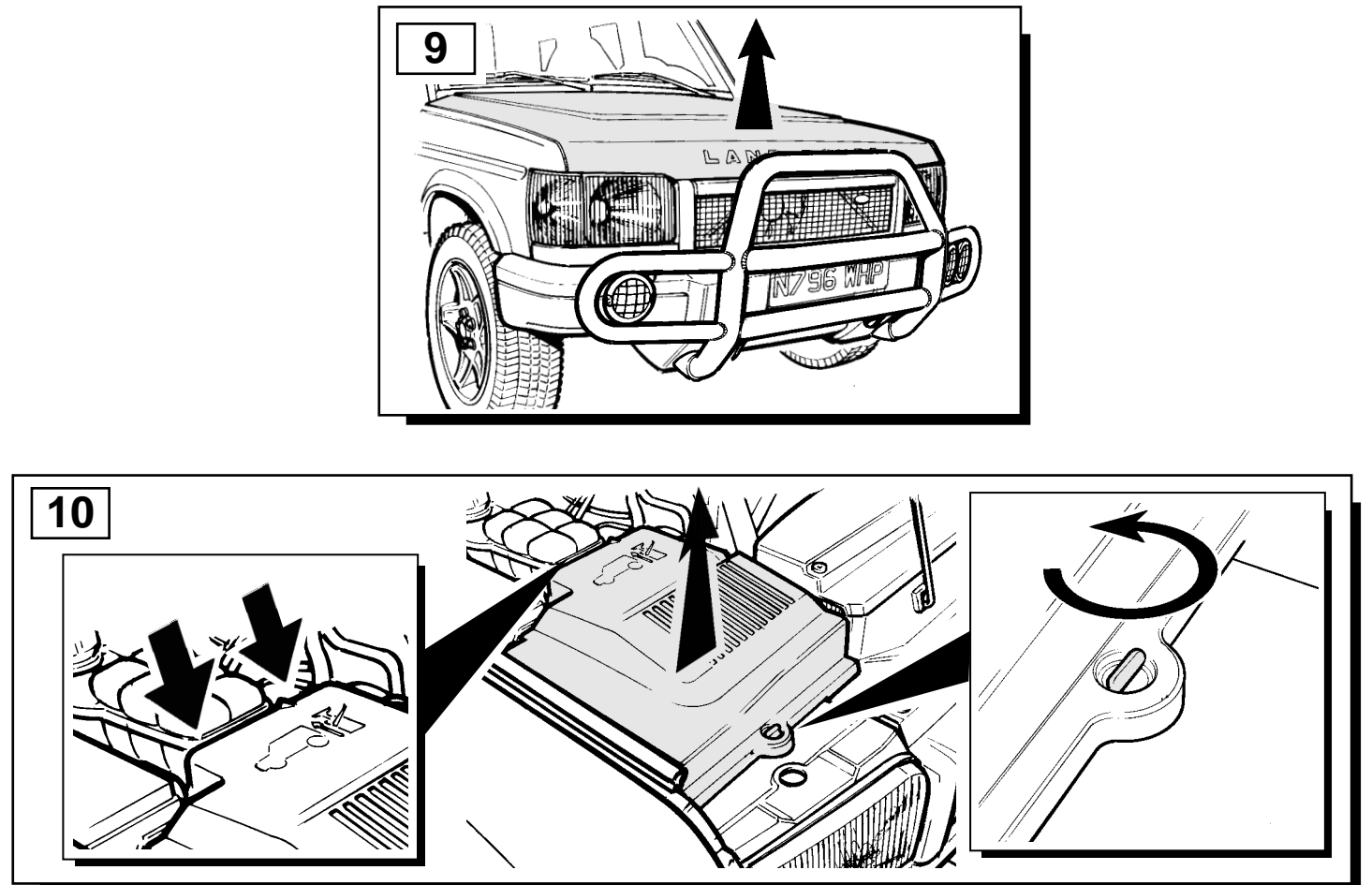
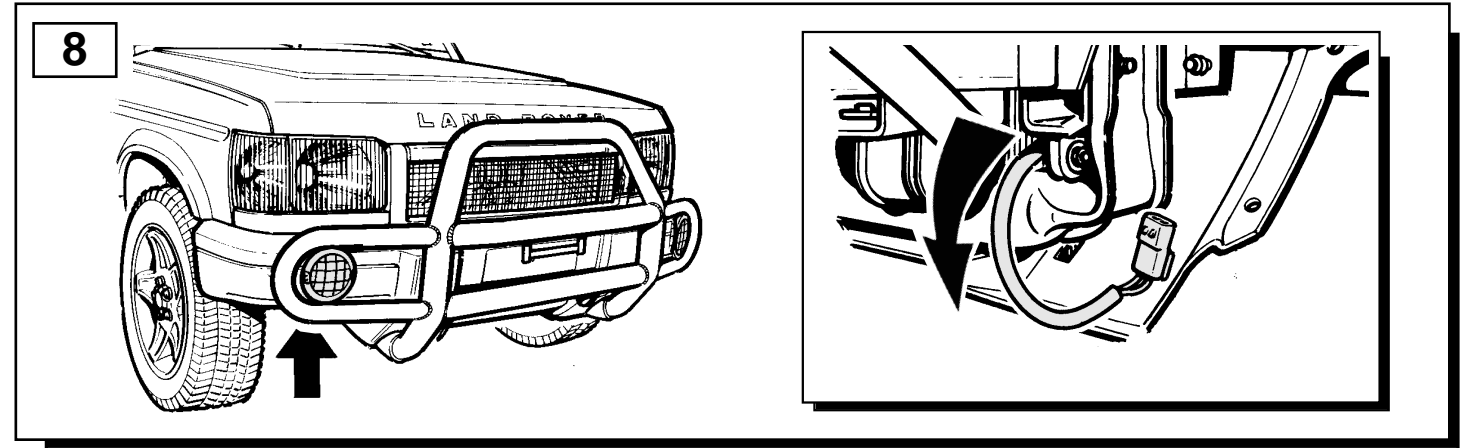
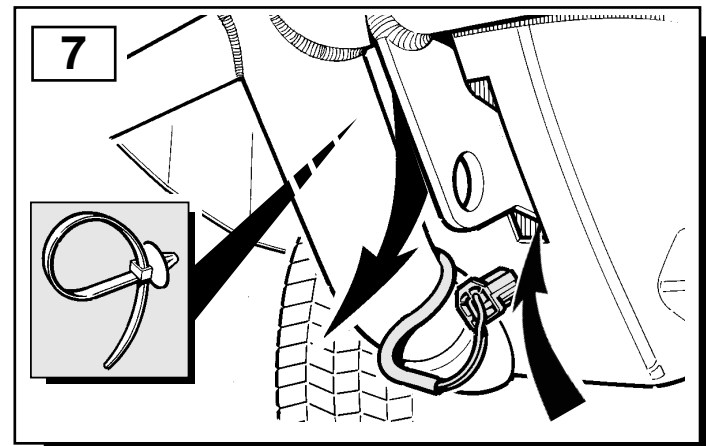
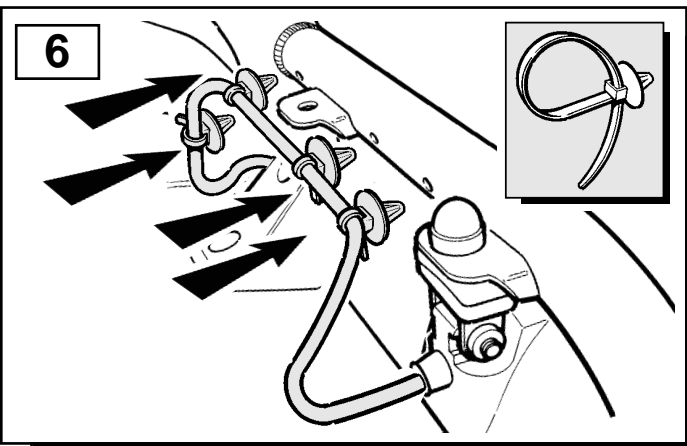
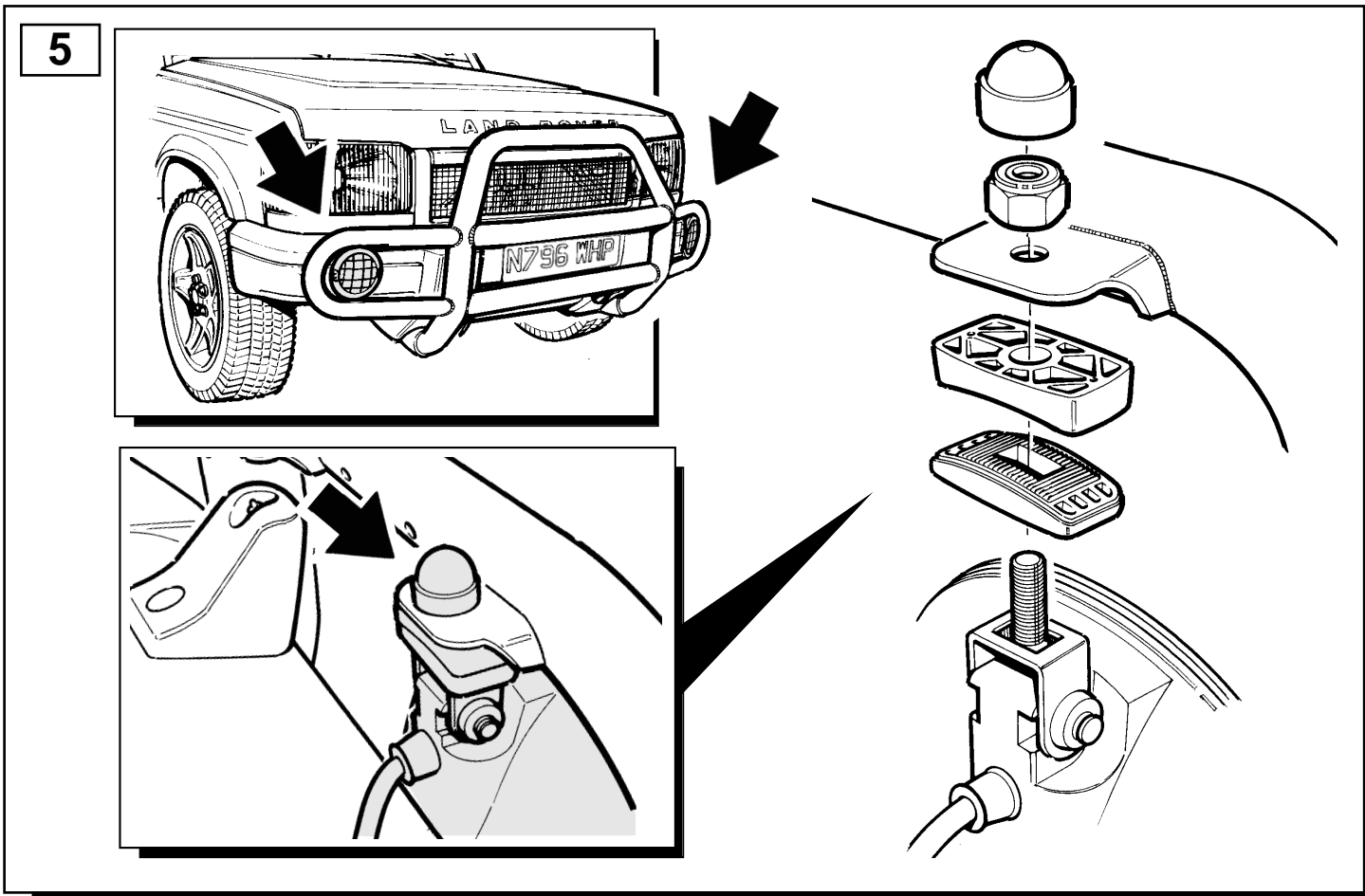
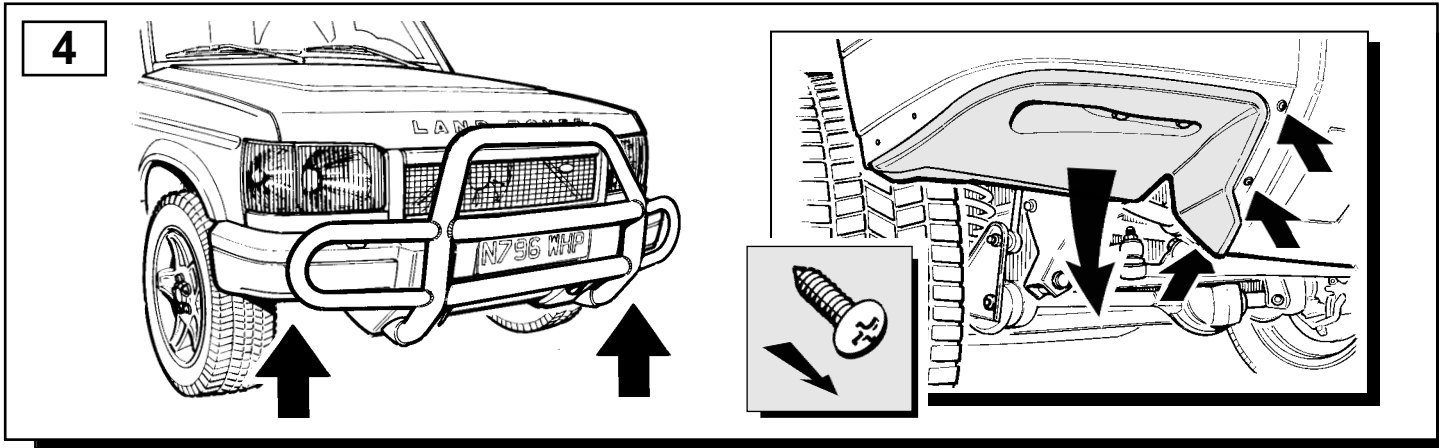

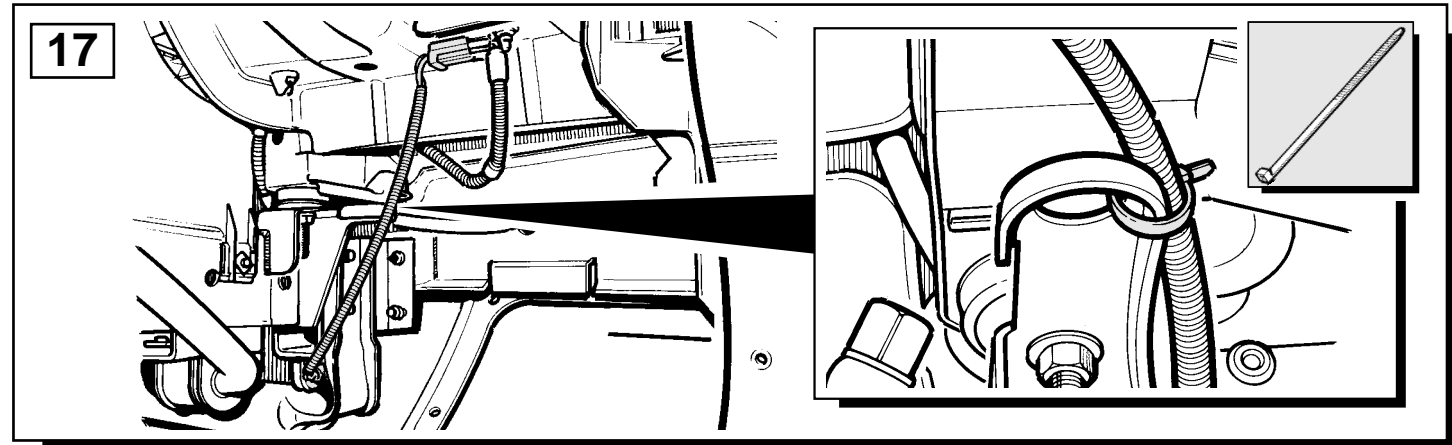
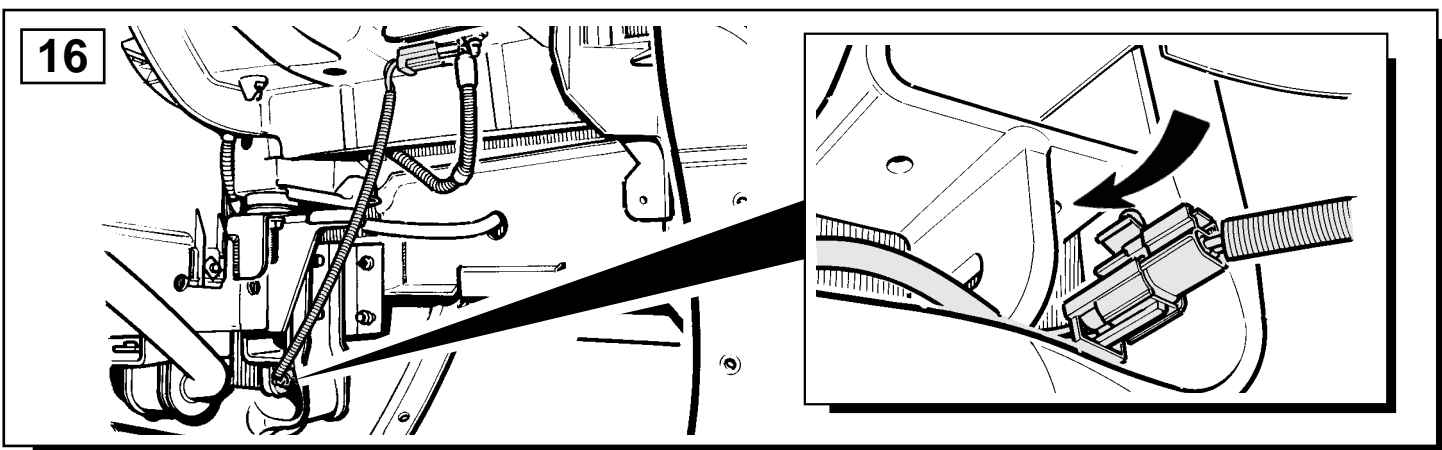
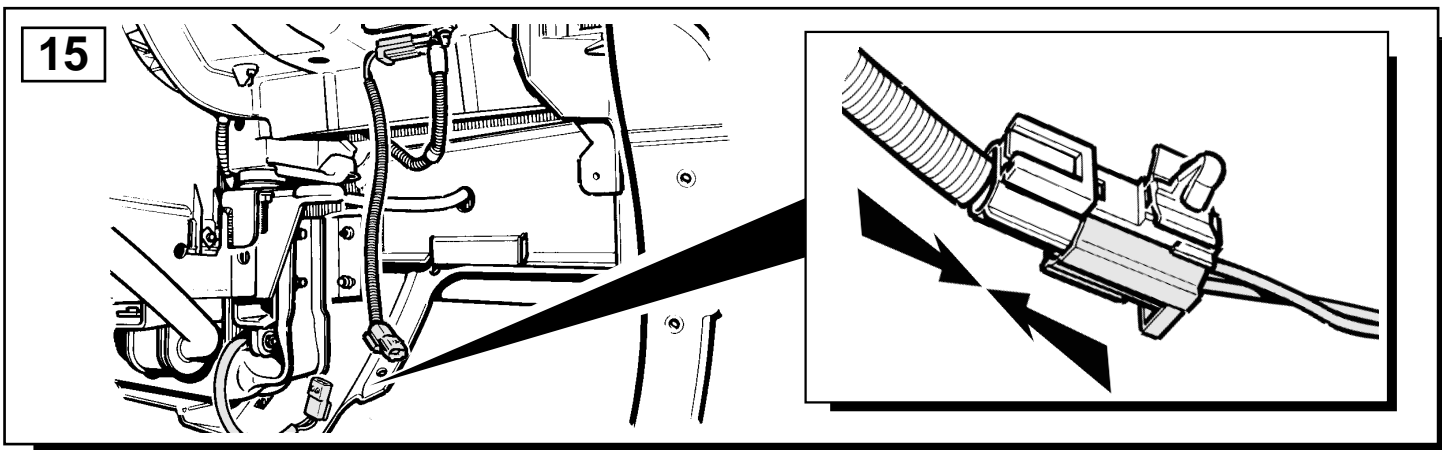
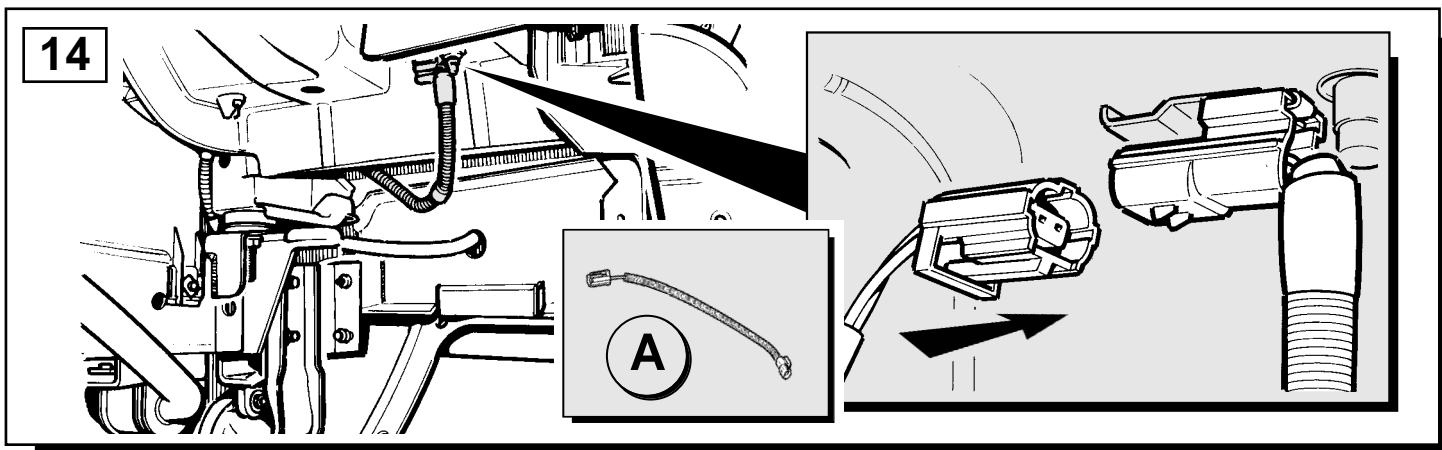
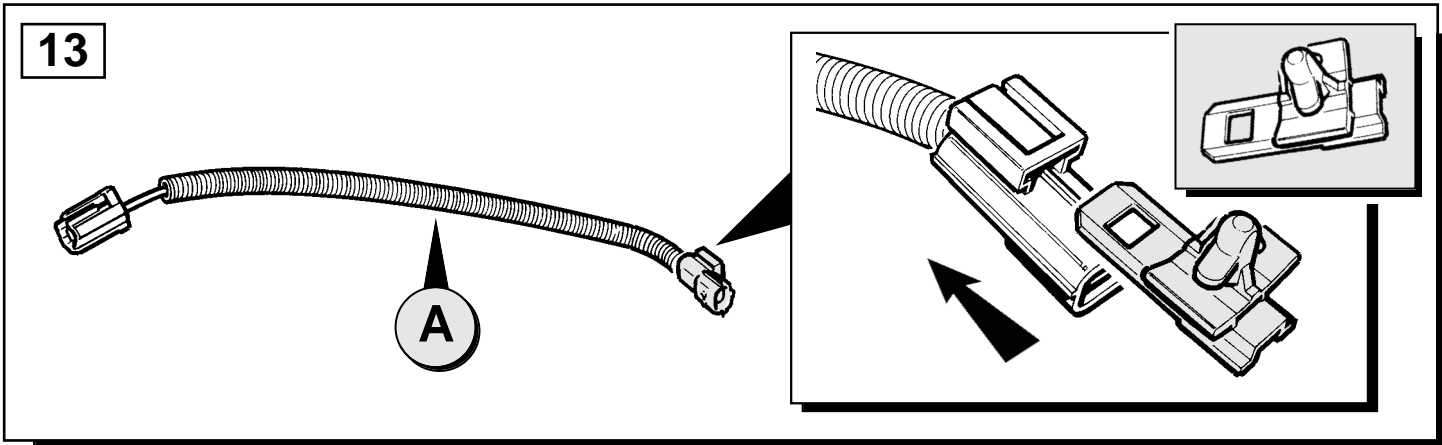

- (GB) Repeat procedure for opposite side.
- (D) Wiederholen Sie den Vorgang für die andere Seite.
- (F) Répéter la procédure sur le côté opposé.
- (I) Ripetere la procedura per il lato opposto.
- (E) Repetir el procedimiento para el lado opuesto.
- (P) Repita o procedimiento para o lado oposto.
- (NL) Volg dezelfde werkwijze voor de andere zijde.
- (GR) Επαναλάβετε τη διαδικασία για την αντίθετη πλευρά.
- (H) 反対側も同じ方法を繰り返す

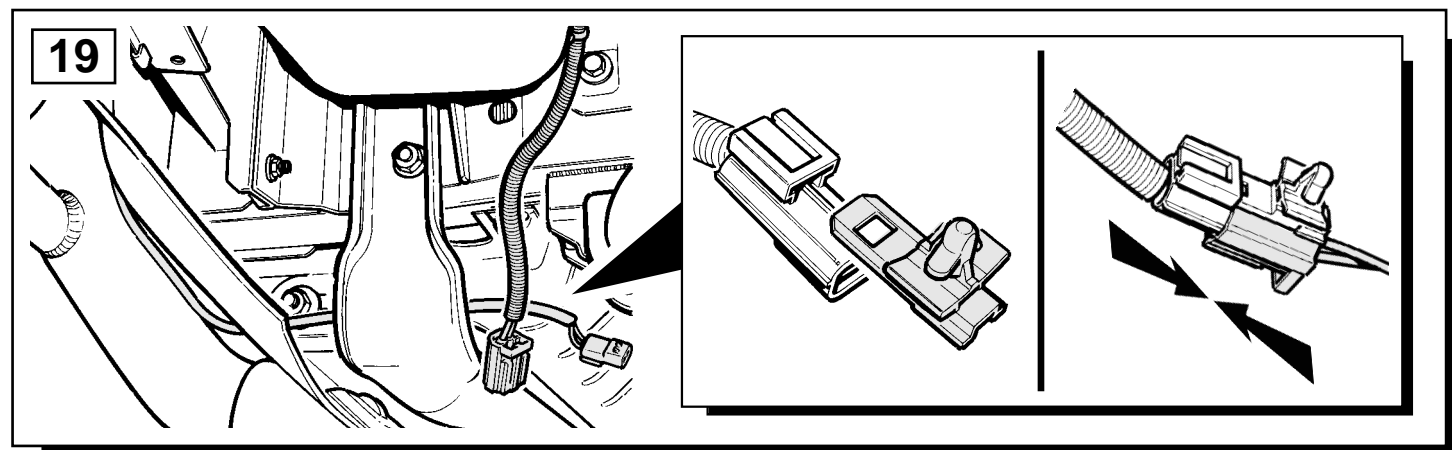
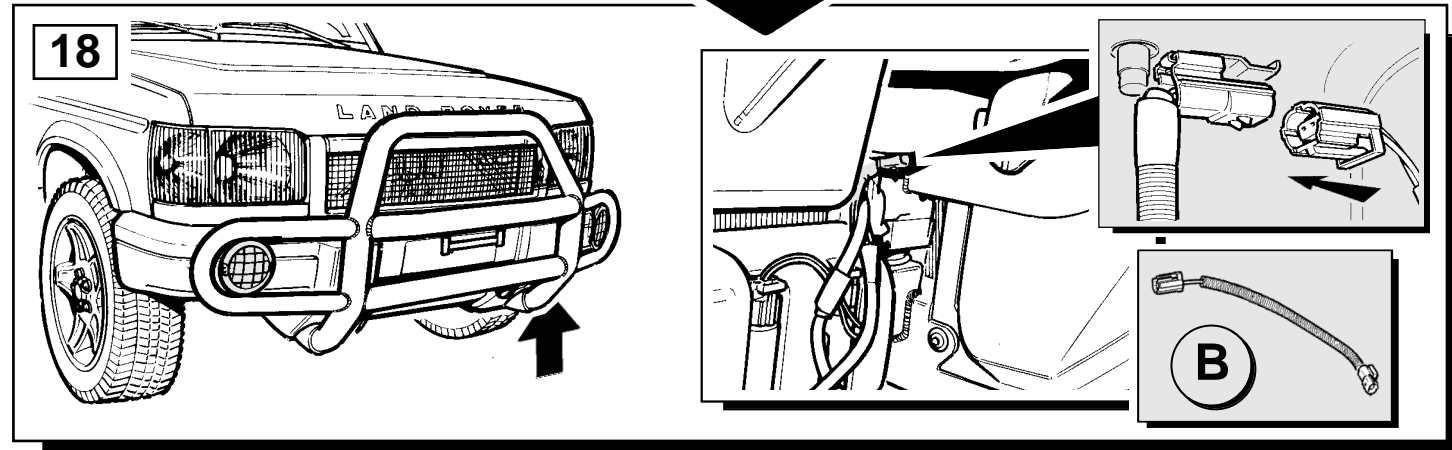

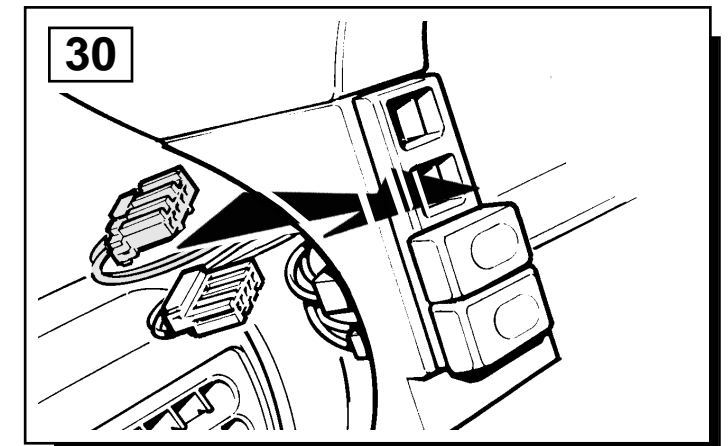
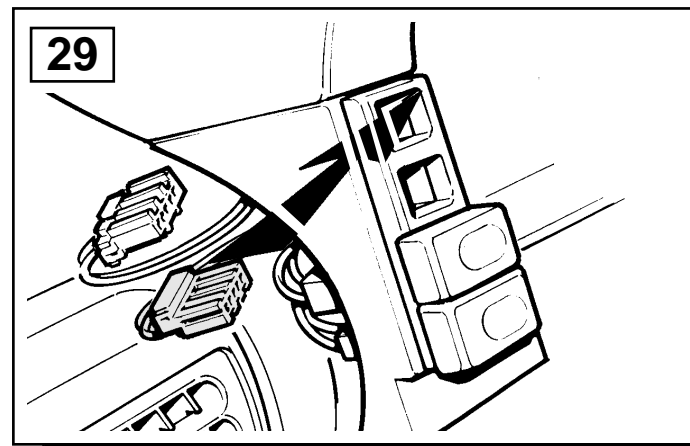
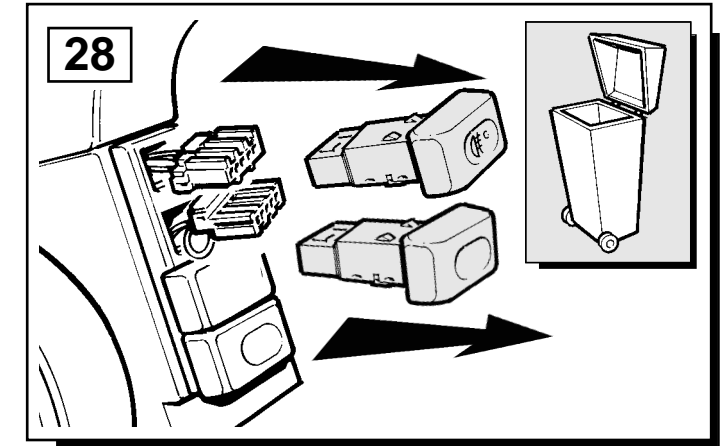
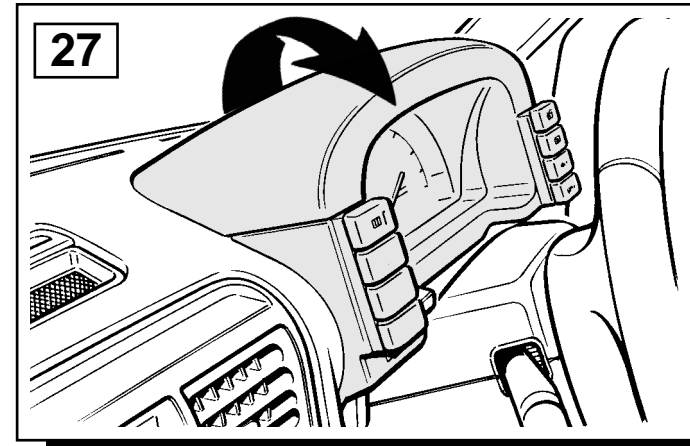
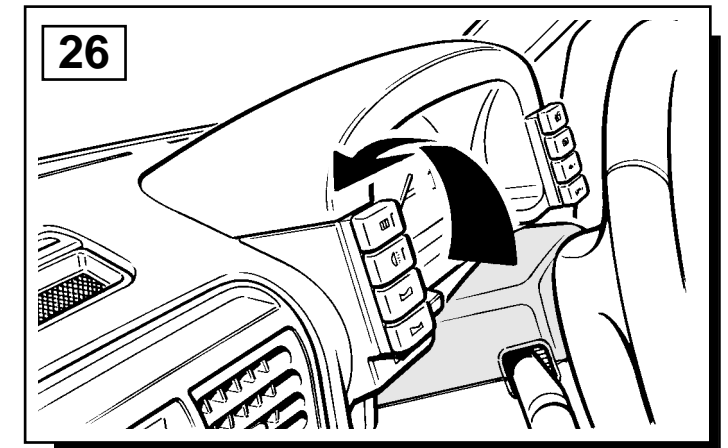
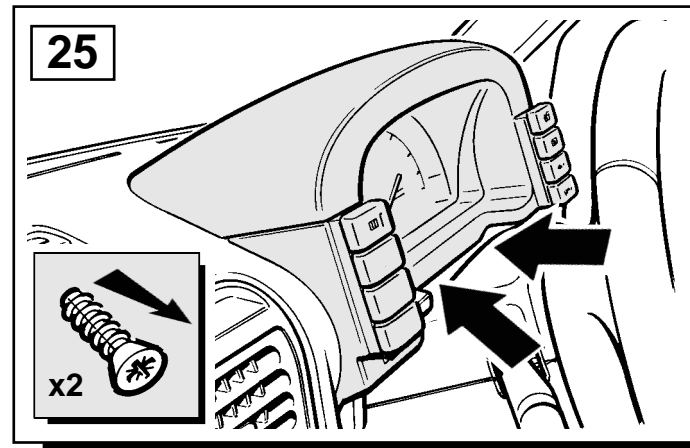
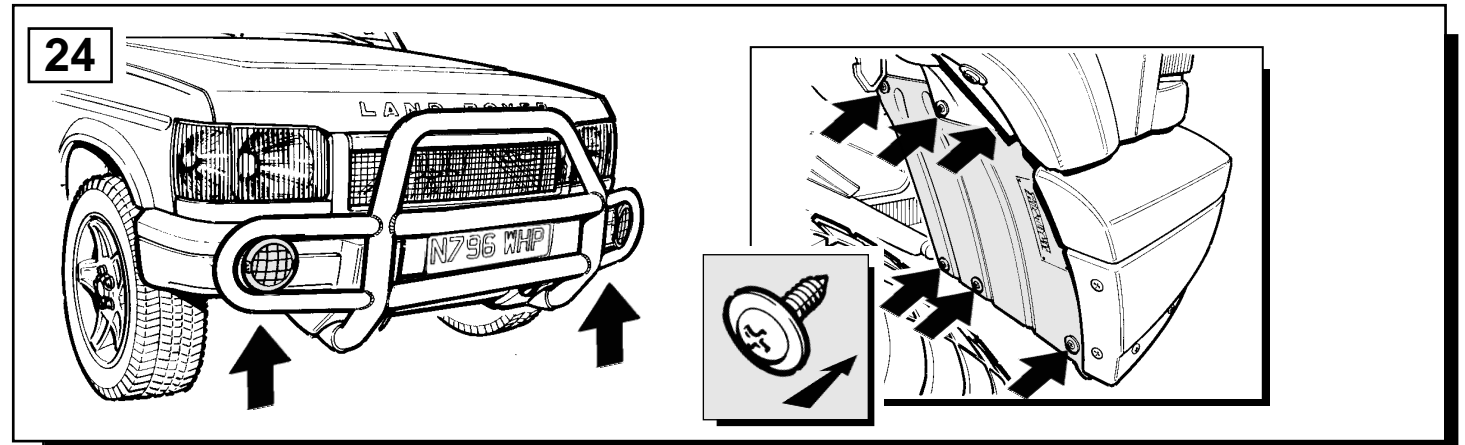
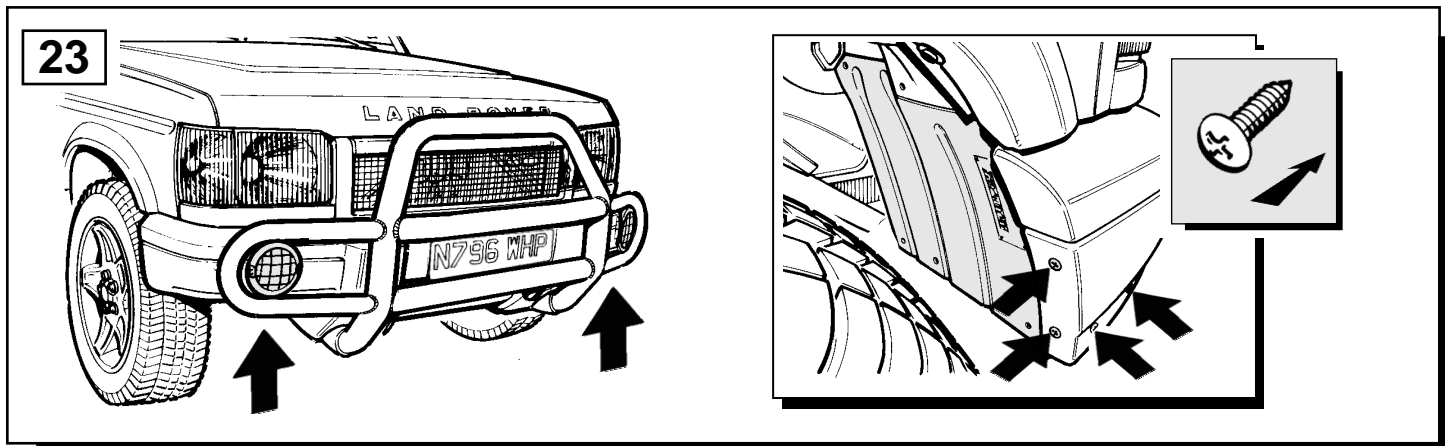
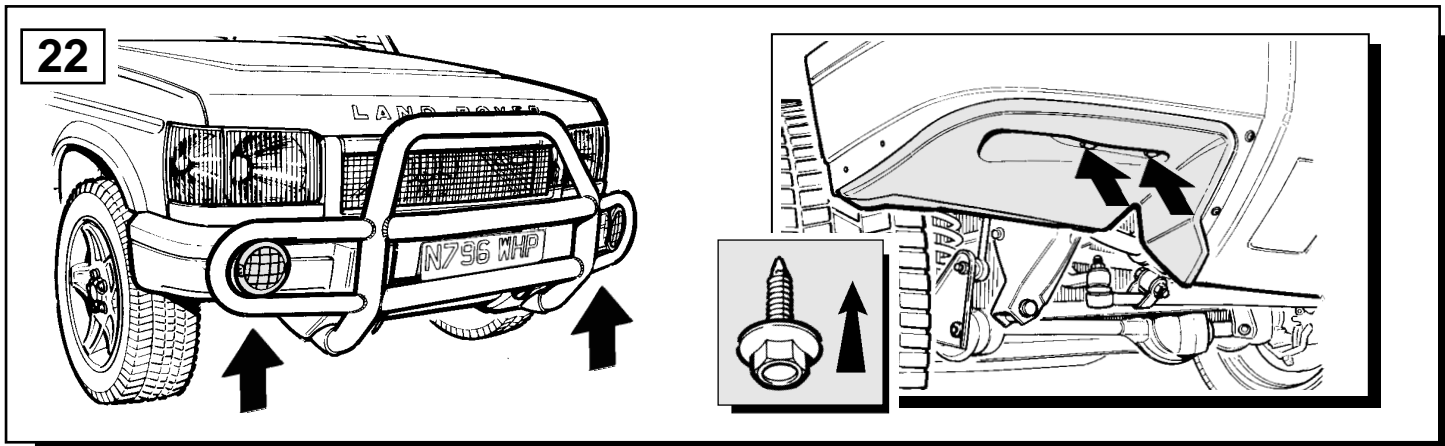
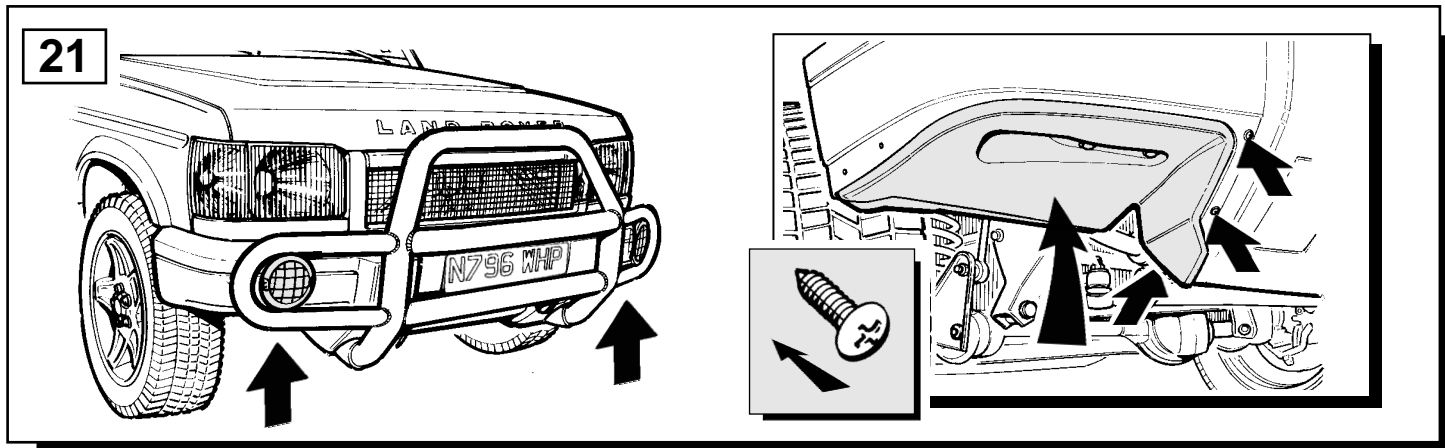
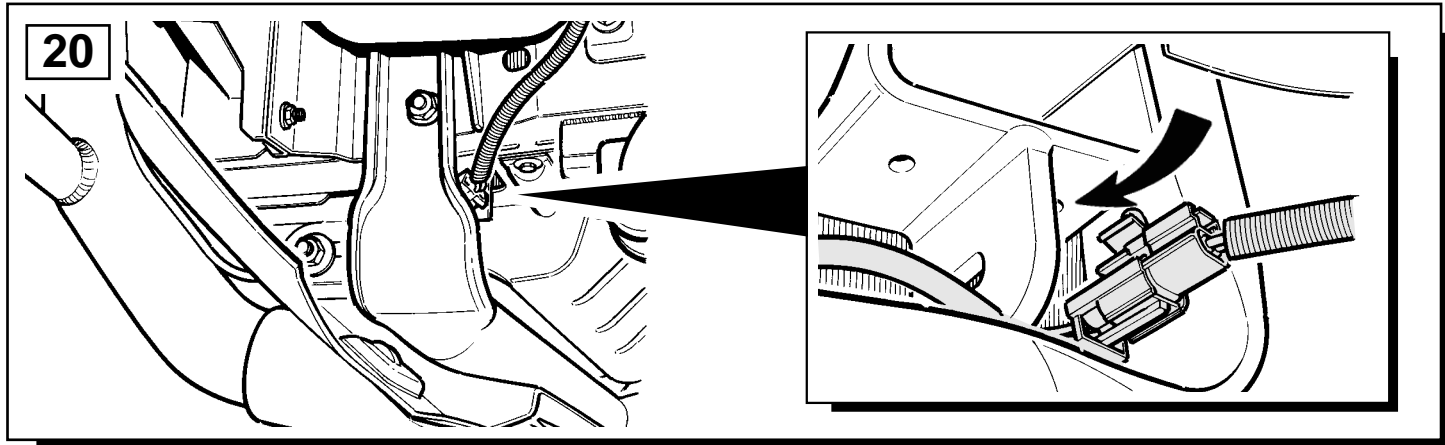

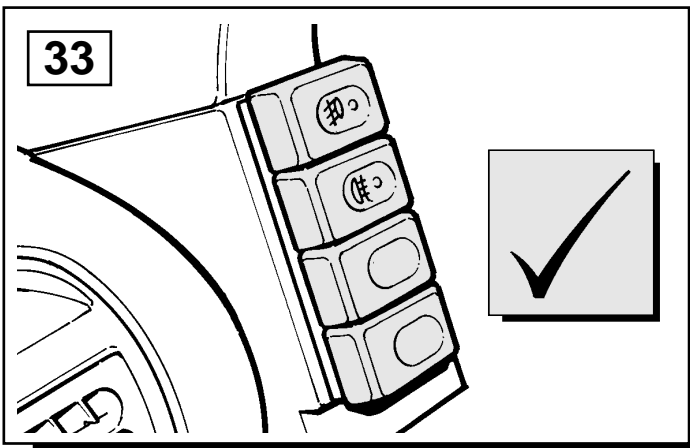
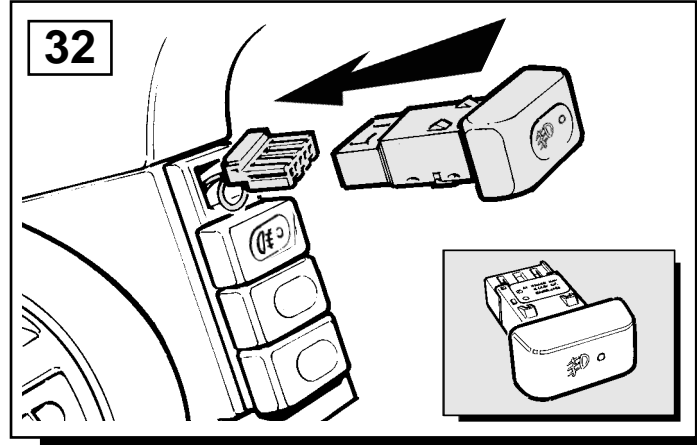
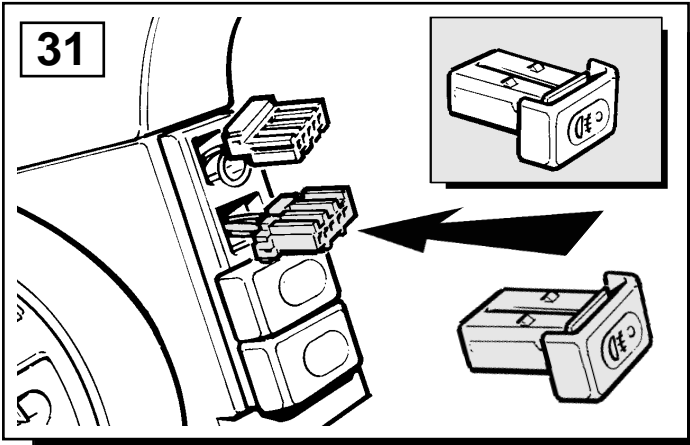

- GB** Use 'Testbook' to configure Fog Lamp Usages.
- D** Benutzen Sie das 'Testbook' zur Konfiguration der Nebelleuchtenbenutzung.
- F** Utiliser le 'Testbook' pour configurer l'utilisation des phares antibrouillard.
- I** Usare "Testbook" per configurare gli usi dei fari fendinebbia.
- E** Utilizar el "Testbook" para configurar los usos de los faros anti-niebla.
- P** Utilize 'Testbook' para configurar as utilizações dos Faróis de Nevoeiro.
- NL** Gebruik 'Testbook' om het gebruik van mistlampen te configureren.
- GR** Χρησιμοποιήστε το 'Testbook' για να ρυθμίσετε τους Προβολείς Ομίχλης.
- E** フォグ ランプの使用については、「Testbook」を使用してください。

